

2SD1428

Fig. t_f TEST CIRCUIT

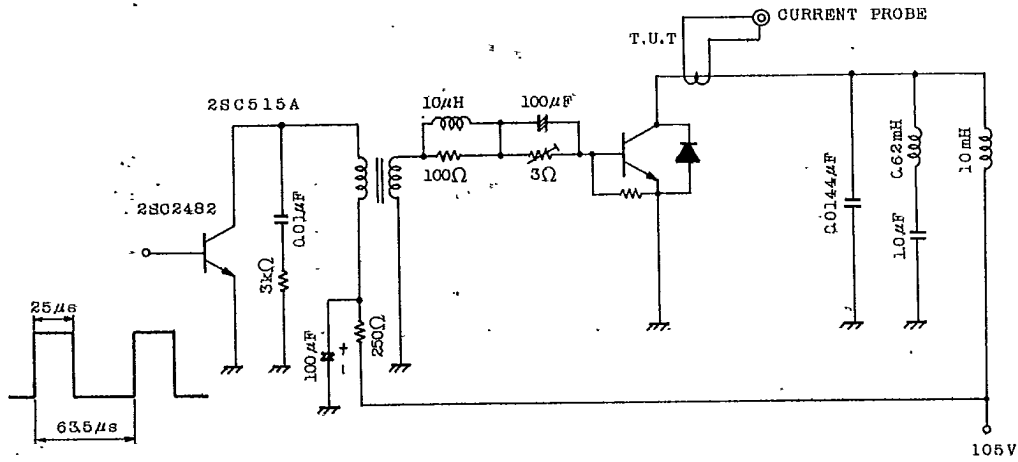

BASE CURRENT

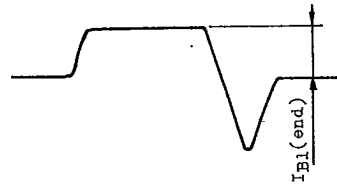

COLLECTOR CURRENT

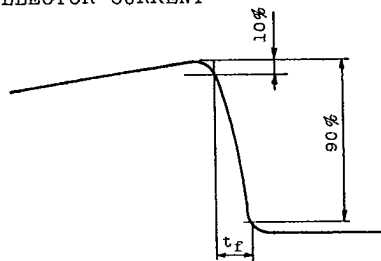

TOSHIBA CORPORATION

2SD1428

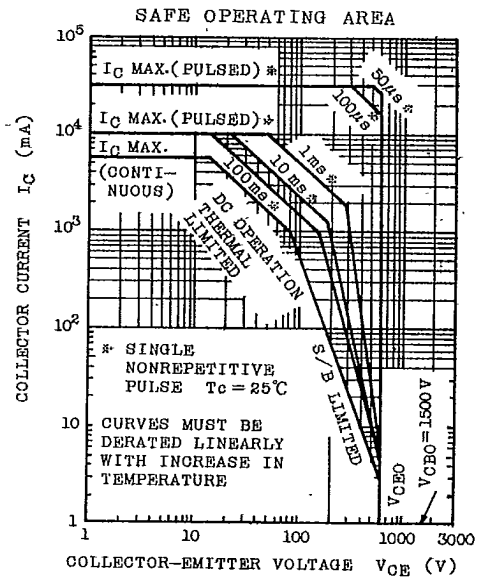
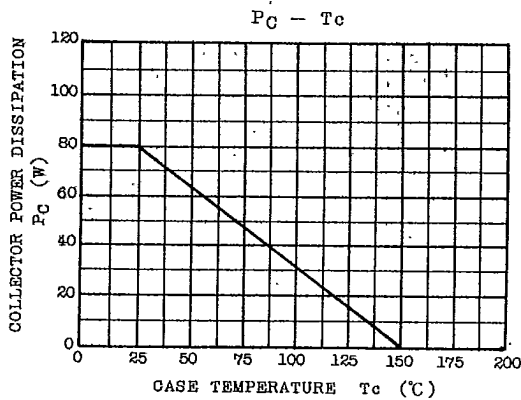
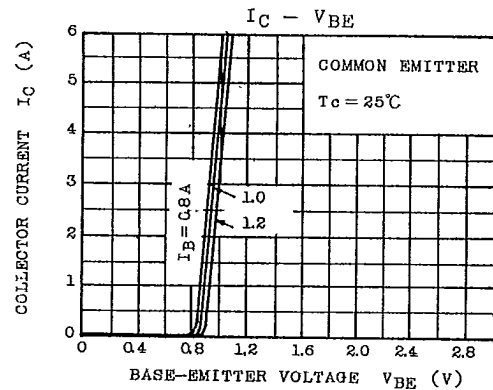
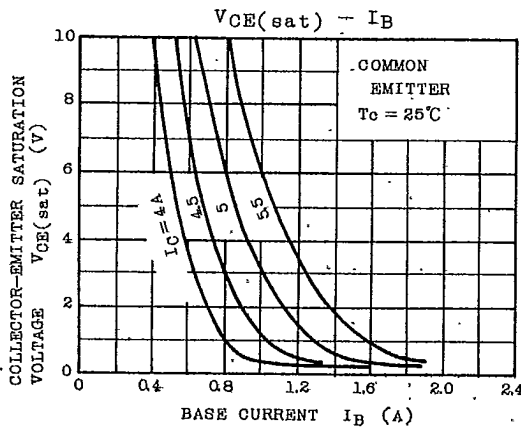
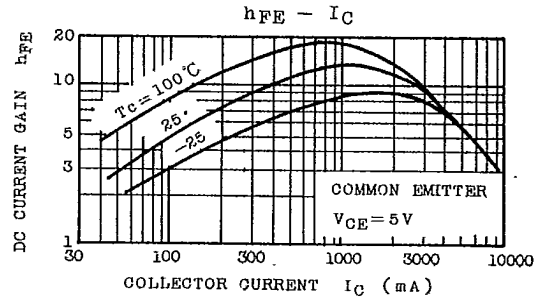
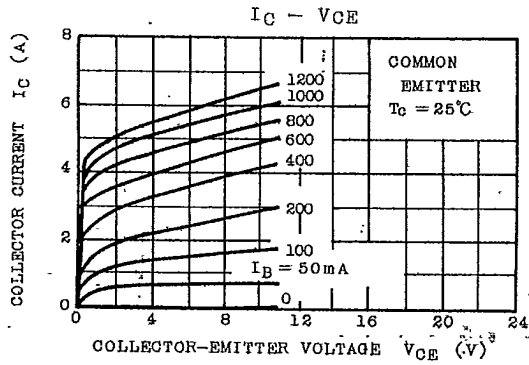

TOSHIBA CORPORATION